

Simrad VHF Radiotelephones

**Shipmate
RS8400
RS8300**

183.2047.005 Rev.1 English

Warning!

The SOS function may only be used in case of emergency and with the correct DSC number coded into the system. The number can be checked by pressing E ↑ 98E for the first five digits and E ↑ 97 E for the last five digits. Do not disconnect the handset while the unit is switched ON.



1832047005

This page is intentionally left blank!

Contents for

RS8400, RS8300, RS8300 SD, and RS8300 SOS

Distress call: Manual	4
Distress call: Automatic - only RS8300 SOS).....	5
Programming of DSC identity number	6
Introduction	7
Handset Status Displays	8
Handset Keys	10
ON/OFF Switch	11
Position Input (RS8300 SOS only)	12
Channel Selection	14
International and US Channels	15
Output Power	16
Squelch	16
Volume	16
Dual Watch	17
Scan All.....	18
Exclusions from Scan All	19
Scan programme.....	20
Edit of Scan Programme	21
Intercom (not RS8300 standard)	22
Muting	23
Illumination	23
Installation	24
- Dual system and watertight socket (not RS8300 standard)	
Optional PA-HAILER (not RS8300 standard)	29
Technical data	30
International Marine VHF Channels	32
US & Canadian Marine VHF Channels	33
International Warranty	34
SIMRAD distributors	35

Manual DISTRESS CALL



16

Select the Distress Channel by pressing the 16 key.

Hold down the PTT lever on the handset.

MAYDAY - MAYDAY - MAYDAY

THIS IS: *State vessel's name three times*

MAYDAY THIS IS: *Repeat vessel's name*

AT POSITION: *State position of vessel*

STATE NATURE OF DISTRESS

Release PTT lever.

Wait for an answer.

If not answered after a short interval, repeat message until answered.

Automatic DISTRESS CALL (DSC)

Caution! The SOS message will alert and activate a rescue operation.
To call off a rescue operation, contact your nearest coastal station.

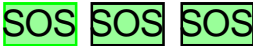
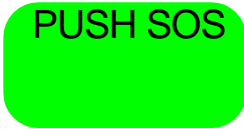

The SOS function is blocked until a DSC number is entered - see overleaf for programming of DSC and ATIS.
Refer to page 12 and 13 for details on Position input and DSC.

Activate automatic transmission of digital DISTRESS CALL by pressing the SOS key three times at intervals of 1 second.



The distress message will be transmitted and repeated automatically at random intervals on Channel 70.

Channel 16 will be available for communication after each transmission.



If not answered after a short interval, try to send your message manually, - see previous page.

Important! After the AUTO SOS has been activated, it must be terminated again (by pressing any key), as it otherwise will continue to send out messages.

Programming of DSC identity number. The DSC number issued by the authorities can be programmed directly from the handset. If a mistake is made, the number can be altered for as long as the unit is still ON, but once the power has been switched OFF, the numbers will be fixed in the memory and can only be reprogrammed by an authorized dealer.

Important! Connected navigator must be disconnected during programming.

Example of how to program a DSC number e.g. 1 2 3 4 5 6 7 8 9 (+0).

Add 0 to a 9 digit DSC number.

E **↑** **9** **2** **E**

Call 1st address: "L"

6 **7** **8** **9** **0** **E**

Key in the 5 least significant digits.

E **↑** **9** **3** **E**

Call 2nd address: "M"

1 **2** **3** **4** **5** **E**

Key in the 5 most significant digits.

Before switching the unit OFF, check that the numbers are entered correctly:

E **↑** **9** **7** **E**

DSC - least significant digits.

E **↑** **9** **8** **E**

- most significant digits.

Programming of ATIS identity number. The ATIS number is issued by the authorities for river traffic in regional areas. Example of how to program an ATIS number e.g. 9 1 2 3 4 5 6 7 8 9 (the first digit will normally be a 9):

E **↑** **8** **2** **E**

Call 1st address: "L"

5 **6** **7** **8** **9** **E**

Key in the 5 least significant digits.

E **↑** **8** **3** **E**

Call 2nd address: "M"

9 **1** **2** **3** **4** **E**

Key in the 5 most significant digits.

Before switching the unit OFF, check that the numbers are entered correctly:

E **↑** **8** **7** **E**

ATIS - least significant digits.

E **↑** **8** **8** **E**

- most significant digits.

Introduction for

RS8400, RS8300, RS8300 SD, and RS8300 SOS

The VHF system is designed for remote installation of the main unit. Operation is carried out through the waterproof handset, which can be installed up to 20 m (65 ft) from the main unit.

Information regarding channel selection, operating mode and output power is always given on the handset display. Volume and Squelch levels are displayed momentarily when settings are changed. Selection of an unauthorised channel is indicated by the legend ERROR.

The keypad has numerical keys for channel selection and function keys for controlling volume, squelch and scan modes. Key **P** (WX) allows access to private, authorised channels. In addition, key **E** allows access to secondary functions. The legend SHIFT will be shown in the handset display whenever this key is pressed. All key entries are acknowledged by short tone in the loudspeaker.

The Press To Transmit lever, located on the left side of the handset, can only be operated when the handset is out of its cradle.

Additional features for the RS8300 SOS version:

The red SOS key ensures a quick and easy way of making a digital distress call, containing the vessel's identity (DSC no.), present position and time. The VHF system will automatically have this information if a GPS navigator is connected, or it can be entered manually via the keypad before activating the distress call.

The handset is supplied with a watertight connector and 5 m extension cable. By adding a second handset and speaker, the system will offer full dual station operation, hailer function and intercom.

Handset Status Displays (International)

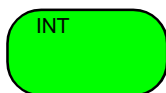

International channels set

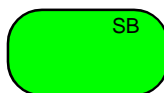

Function in standby

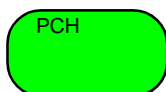

Private channel operative

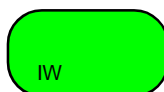

Output reduced

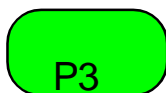

Private channel operative

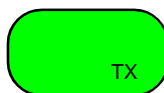

Set is transmitting

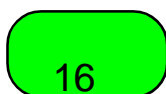

Channel operative

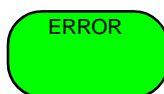

Incorrect selection

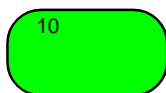

**CH 10
Pre-selected channel**

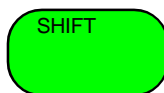

Key E, access to secondary functions

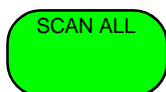

Scan All operative

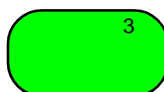

Squelch or volume setting

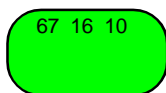

Channels selected for Scan Programme

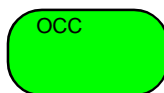

Other handset in use

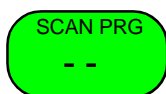

Scan Programme operative

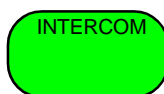

Intercom selected

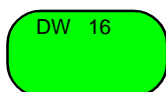

Dual Watch operative

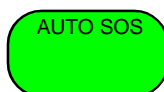

Automatic Distress Call (RS8300 SOS)

Handset Status Displays (US)

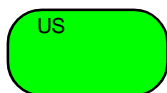

**US
channels set**

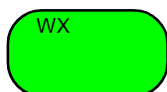

**US
weather channels**

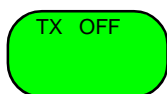

**Transmission
is stopped by time-out**

Handset Keys

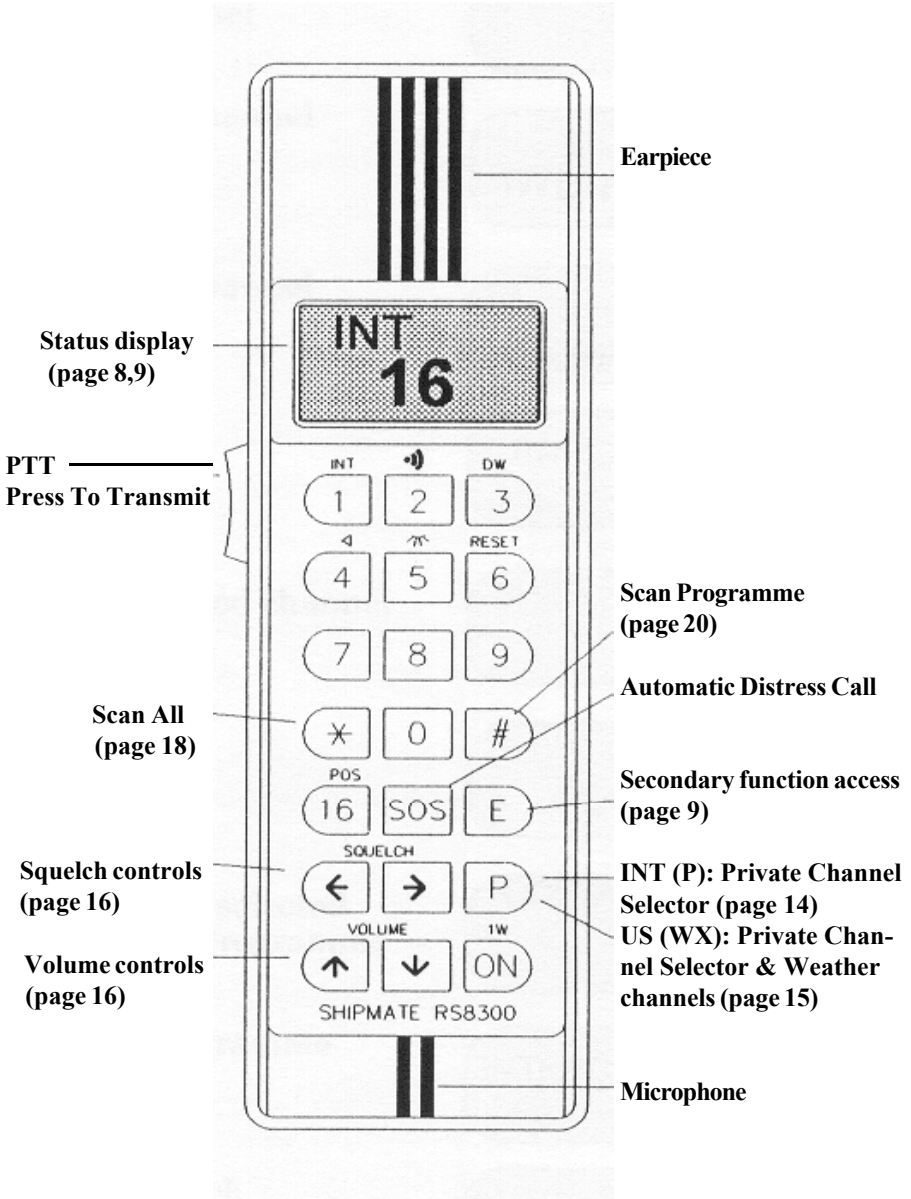

The **ON/OFF switch** is fitted at the base of the main unit and a stand-by facility on the handset allows power consumption to be reduced, so that the set can be left on almost indefinitely.

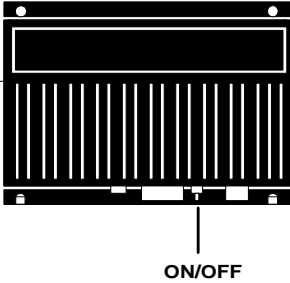

Set the ON/OFF switch of the main unit to the ON position. The system will automatically return to the same status as when it was switched OFF.

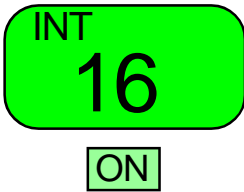

If the display remains blank, the unit is in stand-by mode. Press the ON key of the handset once. The channel will be displayed and the unit will be fully operational.

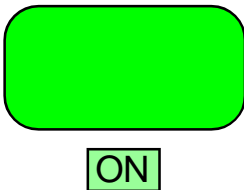

On closing down, press the ON key of the handset and hold it down until the display turns off. The unit is now in stand-by mode.

If the vessel is to be left unattended for any length of time, the ON/OFF switch of the main unit should be set to the OFF position.

Position Input (RS8300 SOS only) is automatically updated if you have a GPS navigator connected to the VHF. Without a navigator, the information can be entered manually from the keypad via the Position menu.

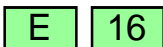

In the Position menu, the display will show the latitude of the last transferred position from a GPS navigator.

Note! The display is not updated while the menu is active.

If no position is displayed, the data can be entered manually.

☞ Press the **E** key to exit the Position menu, or...

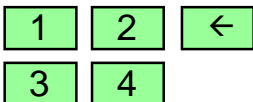

Enter latitude e.g. 12N34

Toggle between N/S with ← / →

Go to longitude with ↓

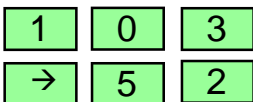
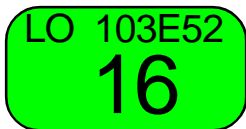

Enter longitude e.g. 103E52

Toggle between E/W with ← / →

Go to UTC time with ↓

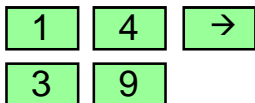

To enter UTC time in hours and minutes
e.g. 14:39 hours.



To acknowledge the position and time input,
press the **E** key.

DSC or Digital Selective Calling is a part of the Global Maritime Distress and Safety System - GMDSS.

This safety system ensures that all coastal stations and commercial vessels automatically will monitor channel 70 for digital distress calls.

GMDSS is being implemented gradually and will be fully deployed before 1999.

Channel Selection allows access to all legally permissible channels. It also permits direct, single key operation for the distress and general calling frequency, Channel 16.

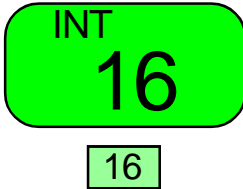

Select the International Distress Channel and General Calling Frequency.

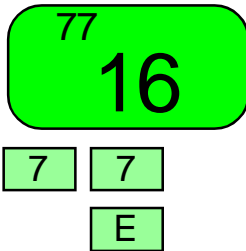

Select any public channel, for example, Ship to Ship Channel 77.

The display will change automatically after 3.5 seconds, or immediately if the **E** key is pressed.

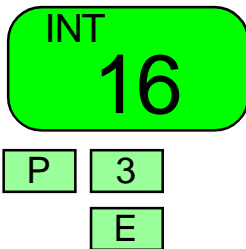

Select a private authorized channel, say Private Channel 3.

This will be displayed 3.5 seconds after selection, or immediately after the **E** key is pressed.

International and US channels may be used with this unit, permitting operation in all waters.

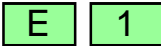
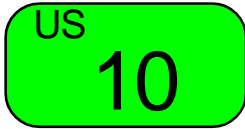

To toggle between US system and International channels, press the **E** key and **1** key. If the legend **ERROR** is displayed, it indicates that US channels are not available.

US channels 13 & 67 are preset to 1W output. This is shown by a flashing 1W on the display. For 25W output, press and hold the PTT key and then press the ON key. When using these channels the handset OFF function will be inoperative.

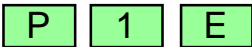
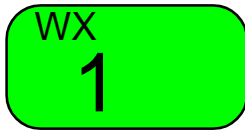

US FUNCTION:

To select the Weather Channels. In the International version, key **WX** is exchanged with key **P**. Refer to page 14 for details on the Private Channels.

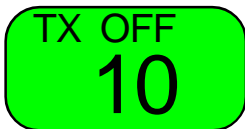

US FUNCTION:

Transmitting continuously for more than 5 minutes, will cause the transmission to turn off. To resume transmission, release the **PTT** key and then press it again.

Output Power can be set to either 1W or to 25W.

Squelch is adjustable in three steps from 1 to 3.

Volume is adjustable in eight steps from 1 to 8.



To reduce output power to 1W for short range transmission. The unit will be set at maximum output when switched ON.

Toggle between 1W and 25W.

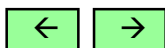
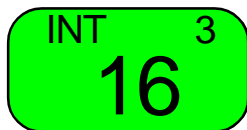

When the set is switched on, the squelch setting will be at 3. In step 1 the receiver is always open.

Adjust squelch with ← / →

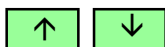

When the set is switched on, the volume setting will automatically be at 3. The speaker volume can be increased in steps up to setting 8.

Adjust volume with ↑ / ↓

Dual Watch will automatically monitor Channel 16 as well as one other channel pre-selected by the operator. It will function only if both handsets are in their cradles.

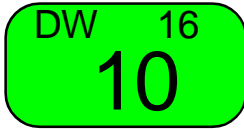

Activate/terminate Dual Watch.



Monitoring of Channel 16 stops when a handset is lifted from its cradle. The pre-selected channel immediately becomes available for communication, and the receiver changes to Stand-by ready to resume Dual Watch when the handset is back in its cradle.

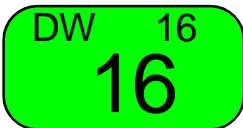

When a signal is detected on Channel 16, the receiver stops monitoring the pre-selected channel, and the legend 16 will be in both channel positions.

It will be locked to Channel 16 until the signals stop or a handset is lifted for use on the pre-selected channel.

Scan All mode monitors all channels for transmissions. *
Squelch must be set above level 1 before this mode can be selected. The Scan function will go in Stand-by mode if the handset is out of its cradle.

** In Europe Channel 16 is always monitored.*

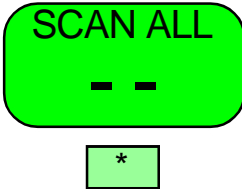

Activate/terminate Scan All.

While scanning is in progress, channel numbers will not be displayed.



When a transmission is detected, the set will lock on for four seconds and display the number of the channel.

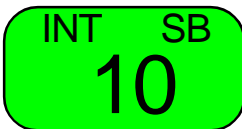

When a handset is lifted, the scanning stops and goes in stand-by mode. The display will show the last received channel.

Exclusions from Scan All can be made for up to six channels. *
This will prevent continuously transmitting stations, such as V.H.F. Direction Beacons, from intruding.

** In Europe it is not possible to exclude Channel 16.*

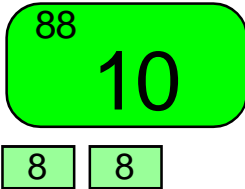

Set in the number of the channel to be excluded from Scan All programme, e.g. Channel 88.

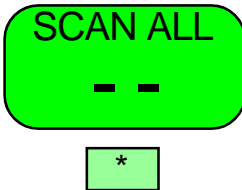

Press the * key immediately, otherwise channel selected for exclusion will instead be “standard channel selection”.

If excluding more than the maximum six allowed channels, the first exclusion will be overwritten by the last entry. Excluded channels will be memorized by the unit.

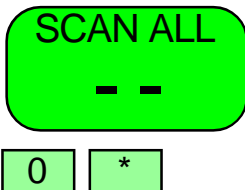

This programme will reinstate all excluded channels in a single operation.

Scan Programme mode allows a limited number of channels to be monitored. *
A minimum of two and a maximum of ten channels can be pre-selected by the operator.

** In Europe Channel 16 is always monitored together with the user-selected channels.*

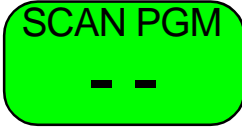

The set will lock on to any detected signal for four seconds, and scanning will automatically continue unless a handset is lifted for communication. Squelch must be set to 2 or 3.

To activate/terminate Scan Programme.

While scanning takes place, channel numbers will not be displayed.



When a transmission is detected, the set will lock on for four seconds and display the number of the channel.



When a handset is lifted, the scanning stops and goes in stand-by mode. The display will show the last received channel.

Edit of Scan Programme memory. Channels selected for Scan programme will be retained in the memory of the set, even if power is switched off. When the memory is full (ten channels), the first one entered is overwritten by the last one entered.

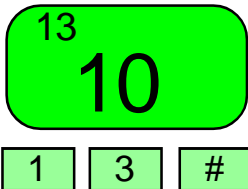

To insert new channels in the Scan Programme memory, e.g. Channel 13.

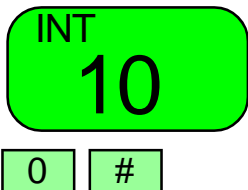

To delete all channels stored in Scan Programme memory.

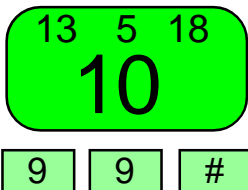

Display the channels stored in Scan Programme memory.

The Intercom (not available in RS8300 standard) facility allows private conversation between the two handsets, or messages over separate loudspeakers, provided there is no radio traffic on the channel selected.

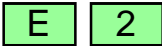

Pick up the handset and press the E key and the 2 key to activate Intercom.

A beep sequence will sound through the loudspeakers.

Press the PTT key to give a message over the loudspeakers, or to communicate with the second handset when it is out of the cradle.



Intercom will automatically go to stand-by when a radio signal is received. Intercom is cancelled when both handsets are returned to their cradles.

Muting completely silences the loudspeakers.

Illumination is set to the low level when the handset is switched on.

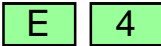
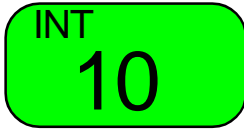

Press the **E** key and the **4** key to mute the loudspeakers.

This setting is automatically cancelled when a handset is replaced in its cradle.

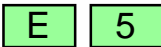
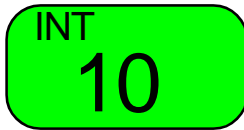

Press the **E** key and the **5** key to adjust the level of illumination.

This function will toggle between three levels of illumination: low, high and off.

INSTALLATION

POSITION & TIME

Interface setup
NMEA 0183 GLL, GGA

(Green) DATA IN
(Red) RETURN

Fuse 6.3A slow blow

Power cable: 1.5m,
2x1.5mm²
Extendable to max.:
5m, 2x1.5mm²
10m, 2x2.5mm²

Speaker cable: 1.5m,
2x0.4mm²
Extendable to max.:
20m, 2x0.4mm²
>20m, 2x0.75mm²

DUAL SYSTEM (NOT RS8300 STANDARD)

**Note! Do not connect 4 ohms
speakers (RS8310 speakers)
in parallel.**

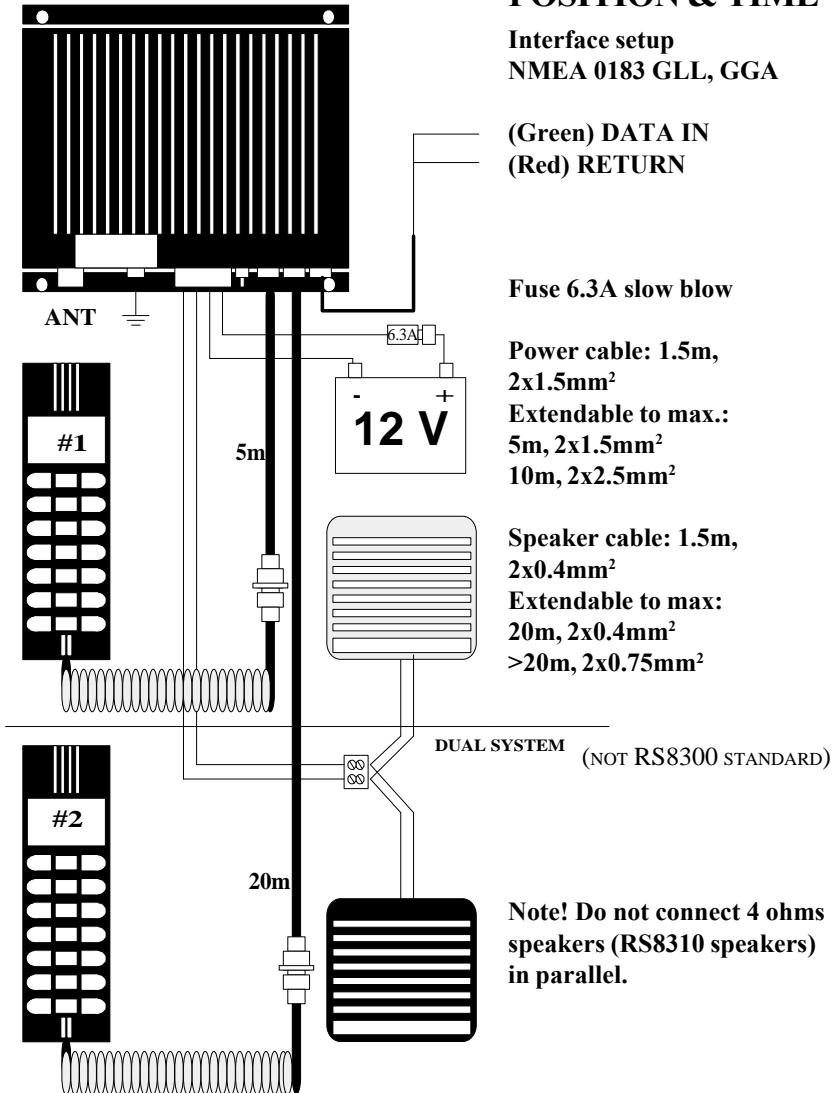

INSTALLATION

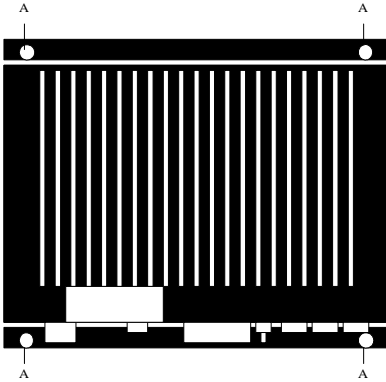

Installation of transceiver unit, handset cradle and watertight socket. (Optional).

The transceiver unit is not waterproof, so it will have to be installed in a dry place.

1. Fasten the transceiver unit with the 4 screws (included) in the holes marked A.

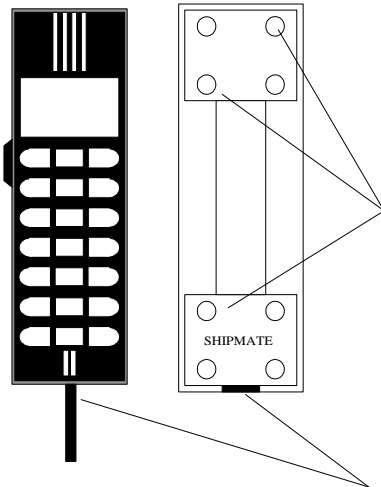

2. Fasten the handset cradle with minimum 4 screws (included).

Take care that the cradle is not mounted upside-down, as the plastic spring has a cutout for the cable.

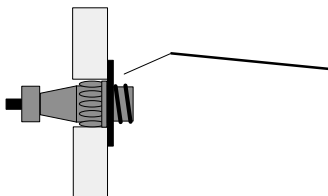

3. Drill a Ø22mm hole for the watertight socket.

4. Place the socket in the hole and drill four Ø2mm holes for the included 4 screws.

INSTALLATION

Installation of speaker

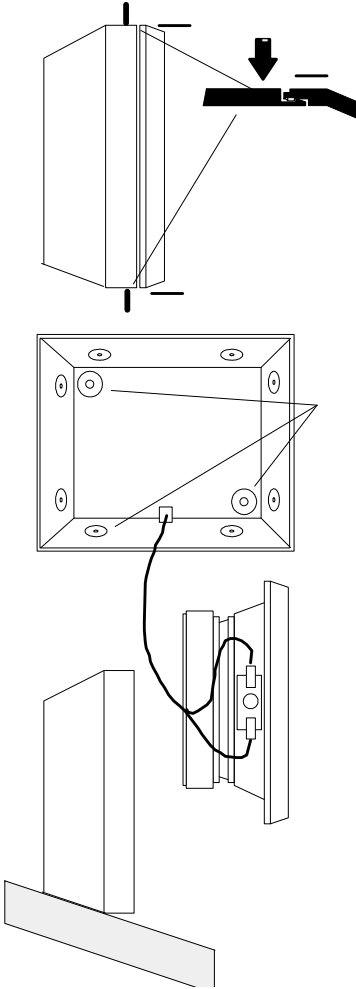

1. Open the speaker by pressing firmly on the top and bottom of the back part, and at the same time pull the front part forward.

2. Drill out the appropriate holes for installation with a Ø4mm drill.

3. Lead the speaker cable through the hole of the rear part.

4. Fasten the rear part with the included screws.

5. Connect the speaker cables to the connection terminals.

6. Take the front part of the speaker and press it back together with the rear part.

Note! Speakers for the dual version are supplied with fixed cables and switch.

INSTALLATION

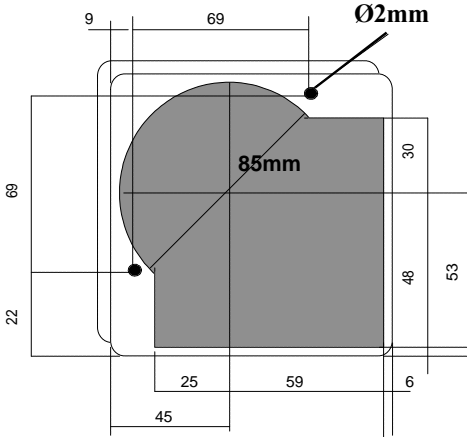

How to flush mount a speaker

1. Locate the exact position for the speaker.

2. Cut out the hole as indicated (shaded area).

3. Drill two Ø2mm holes.

4. Fasten with two 3x14mm selftapping screws (not included).

5. Insert the speaker into the cut-out and slide it into its correct position. The two screws will lock into two keyhole-shaped holes.

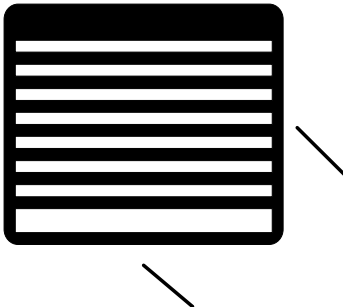
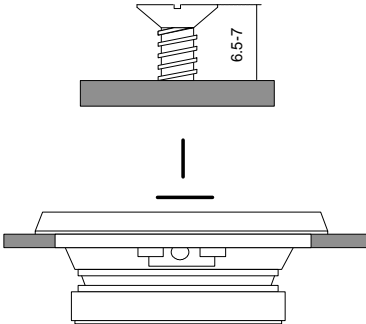

INSTALLATION

Multiple handset connections

- up to three handsets can be connected simultaneously.

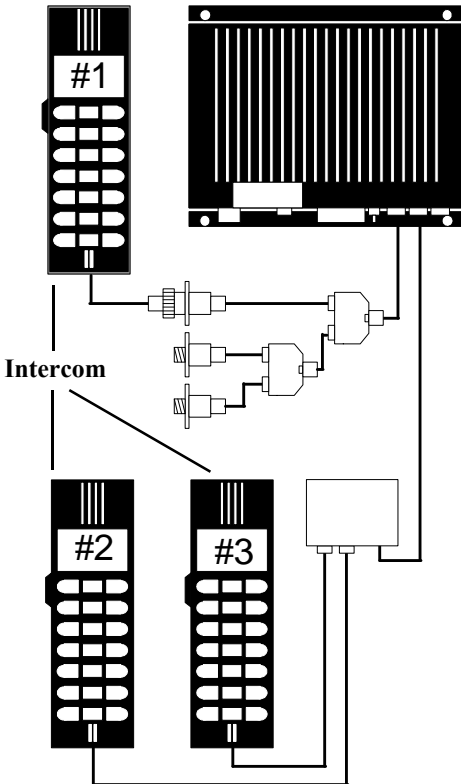

Dual outlet for two or more handset sockets.

Part no. 157.2014.001

Note! Only one handset should be connected at a time, as the sockets are in parallel.

Dual connection box for two handsets.

Part no. RS8321

Handset #2 and #3 will have equal second priority, and both can intercom with #1.

OPTIONAL PA-HAILER

(not available in RS8300 standard)

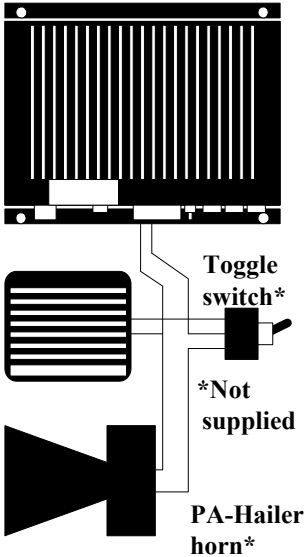

Installation and operation of PA-HAILER

Pick up one handset.

Place the toggle switch in HAIL position.



Select Intercom

Press PTT to HAIL

Terminate the function by resetting the toggle switch to RS8300 speaker, and place the handset back in its cradle.

TECHNICAL DATA

General

Power supply:	13.2V dc (12V nominal) isolated earth. Reverse polarity protection.
Operating voltage:	10.8 to 15.6V dc
Power drain:	
- receive:	1.8W / 150mA
- transmit (25W):	60W / 5A
- transmit (1W):	10W / 0.8A
- stand-by:	60mW / 5mA
Mode:	Simplex / Semi Duplex
Channels:	54 International / US, 16 Private
Facilities:	Scanning, Dual Watch, Priority Key, DSC - class C (automatic distress call)
Frequency range:	153.9 - 163.1 MHz
Antenna impedance:	50 ohms
Connector:	PL 259
Navigator input:	NMEA 0183 - GLL and GGA string.

Transmitter

Power output:	
- high:	23 - 25W
- low:	1W
AF distortion:	<3%
Microphone sensitivity:	22mv / 600 ohms

Loudspeaker:	8 ohms, 8W
Dimensions:	110x100x47 (4.4x4x1.9")
Weight:	0.4 kg

TECHNICAL DATA

Receiver

Sensitivity:	0.3 μ v / 12 dB SINAD
Squelch sensitivity:	Threshold 10dB quieting max. 2 μ v
AF output power:	4W / 8 ohms
Headphone output:	0.775v / 600 ohms

Construction

Main unit:	Moisture resistant. Must be located inside, away from possible exposure to water.
Dimensions:	184x155x42mm (7.2x6x1.6")
Weight:	1 kg
Handset:	Water resistant. Handset may be placed in an open cockpit and on the flybridge.
Compass safe distance:	1m
Dimensions:	192x60x27mm (7.5x2.3x1")
Weight:	0.25 kg
Environmental:	-10° to +55°C / 95% rel.

INTERNATIONAL MARINE VHF CHANNELS

C= Channel

D= Duplex

☐= Only DK, N, S, SF

P= Public

H= Harbour

■= Only N, SF

S= Ship to Ship

X= Receive only

◆= Only UK

●= 25 Watt

⊙= 1 Watt

C	D	P	H	S	Remarks	C	D	P	H	S	Remarks	
1	●	●	●			60	●	●	●			
2	●	●	●			61	●	●	●			
3	●	●	●			62	●	●	●			
4	●	●	●			63	●	●	●			
5	●	●	●			64	●	●	●			
6				●		65	●	●	●			
7	●	●	●			66	●	●	●			
8				●		67			●			
9			●	●		68			●			
10			●	●		69			●	●		
11			●			70	DIGITAL SELCALL					
12			●			71			●			
13			●	●		72				●		
14			●			73			●	●		
15			●	●		74			●			
16	SAFETY & CALLING CHANNEL					77				●		
17			●	●		78	●		●			
18	●		●			79	●		●			
19	●		●			80	●		●			
20	●		●			81	●		●			
21	●		●			82	●	●	●			
22	●		●			83	●	●				
23	●	●				84	●	●	●			
24	●	●				85	●	●				
25	●	●				86	●	●				
26	●	●				87	●	●				
27	●	●				88	●	●				
28	●	●										
P1				◆	157.850 MHz	P1 = L1				☐	155.500 MHz	
P2				◆	161.425 MHz	P2 = L2				☐	155.525 MHz	
P3						P3 = L3				■	155.650 MHz	
P4						P4						

US & CANADIAN MARINE VHF CHANNELS

C= Channel

D= Duplex

●= 25 Watt

P= Public

H= Harbour

⊙= 1 Watt

S= Ship to Ship

★= Receive only

◆= USCG only

C	D	P	H	S	Remarks	C	D	P	H	S	Remarks	
1			●	●		60	●	●	●			
2			●	●		61	●	●	●			
3			●	●		62	●	●	●			
4			●	●		63			●	●		
5			●	●		64	●	●	●			
6				●	Safety	65			●	●		
7			●	●		66			●	●		
8				●		67				⊙		
9			●	●		68			●	●		
10			●	●		69			●	●		
11			●	●		70	DIGITAL SELCALL					
12			●	●		71			●	●		
13			⊙	⊙		72				●		
14			●	●		73			●	●		
15					★	74			●	●		
16	SAFETY & CALLING CHANNEL					77				●		
17			⊙		State controlled	78			●			
18			●	●		79			●			
19			●	●		80			●			
20	●		●			81			◆	◆		
21			◆	◆		82			◆	◆		
22			◆	◆		83			◆			
23			◆			84	●	●	●			
24	●	●			Marine operator	85	●	●				
25	●	●			Marine operator	86	●	●				
26	●	●			Marine operator	87	●	●				
27	●	●			Marine operator	88				●		
28	●	●			Marine operator							
WX1 WEATHER 162.550 MHz ★						WX6 WEATHER 162.500 MHz ★						
WX2 WEATHER 162.400 MHz ★						WX7 WEATHER 162.525 MHz ★						
WX3 WEATHER 162.475 MHz ★						WX8 WEATHER 161.650 MHz ★						
WX4 WEATHER 162.425 MHz ★						WX9 WEATHER 161.775 MHz ★						
WX5 WEATHER 162.450 MHz ★						WX10 WEATHER 163.275 MHz ★						

SIMRAD warrants that every product shall be free of defects in material and workmanship as specified below:

CATEGORY “A”: *Autopilots *Radars *Instruments *Navigators *Radiotelephones *Plotters *Gyro compasses *Sonars *Echo sounders *Trawl Instrumentation.

These products are warranted for a period of 24 months on parts and 12 months on labour from date of purchase, except for category B items. Consumable parts such as lamps, fuses, batteries, bearings etc. are not covered by this warranty.

CATEGORY “B”: *Antennas *Transducers *Trawl sensors *Monitors (CRT) *Gyro sensitive elements *Radar magnetrons *Disk drives.

These items are warranted for a period of 12 months on parts and labour from date of purchase.

WARRANTY SERVICE is available through authorised service dealers or national distributors worldwide. Products returned will, at the sole discretion of Simrad, either be repaired or replaced free of charge within normal working hours. Freight charges, insurance, duties or any other costs are the responsibility of the customer.

Maximum liability shall not, in any case, exceed the contract price of the products claimed to be defective.

ON BOARD SERVICE can be arranged by authorised local service dealers or national distributors upon request. Labour costs for the repair/replacement of the defective modules/parts will be free of charge provided a valid warranty is confirmed. Overtime, travel, lodging, per diem, insurance, duties or any other costs are the responsibility of the customer. Additional expenses connected with replacement of transducers such as dry docking, diving and precautionary measures are not covered by this warranty.

VALIDITY: This warranty is effective only when warranty certificate or proof of purchase and equipment serial number is presented. Furthermore, the installation and operation has to be carried out in accordance with the product manual. Warranty liability does not apply to any equipment which has become inoperative due to misuse, accident, neglect, sea water damage or unauthorised repair. Simrad will not be liable for any loss, incidental or consequential damages whether based on negligence, or arising in connection with the sale, installation, use or repair of the product. Consequential damages include, but are not limited to, any loss of profit, property damage or personal injury.

The terms of warranty as described does not affect your statutory rights.